

SINK AND TRAY WASTE 3 PART

1-1/2" x 25"

41-01000 rough brass
41-01500 satin plated
for PVC see page 77

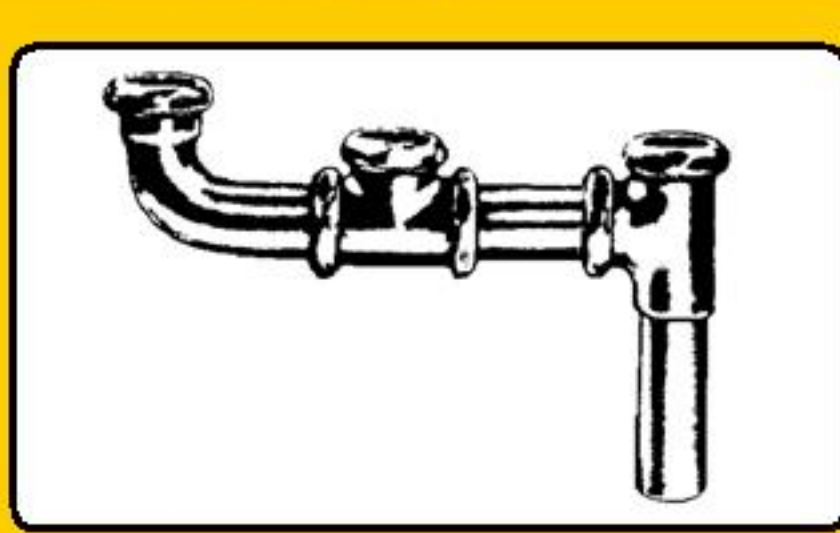

END OUTLET SINK AND TRAY WASTE

1-1/2" x 25"

41-13000 rough brass
41-13500 satin plated
for PVC see page 77



QUICK HOOK UP

END OUTLET SINK AND TRAY WASTE

1-1/2" x 25"

41-02000 rough brass
41-02500 satin plated
for PVC see page 77



CENTER OUTLET SINK AND TRAY WASTE

41-11018 18" rough brass
41-11024 24" rough brass
for PVC see page 77

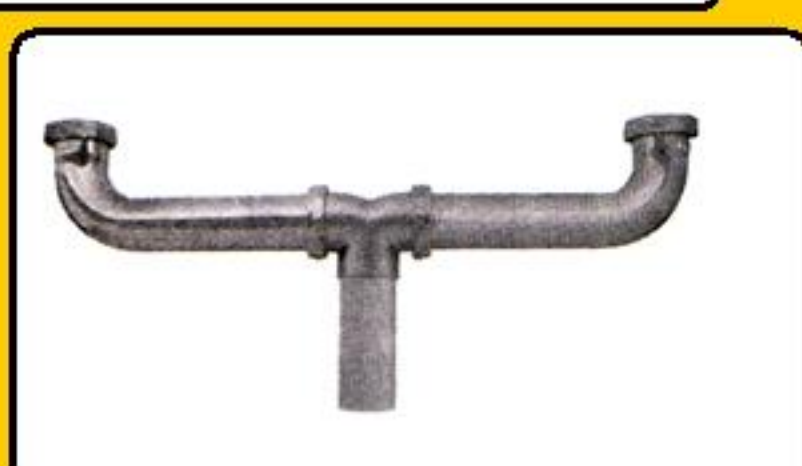

QUICK HOOK UP

CENTER OUTLET SINK AND TRAY WASTE

1-1/2" x 25"

41-05000 rough brass
41-05500 satin plated
for PVC see page 77

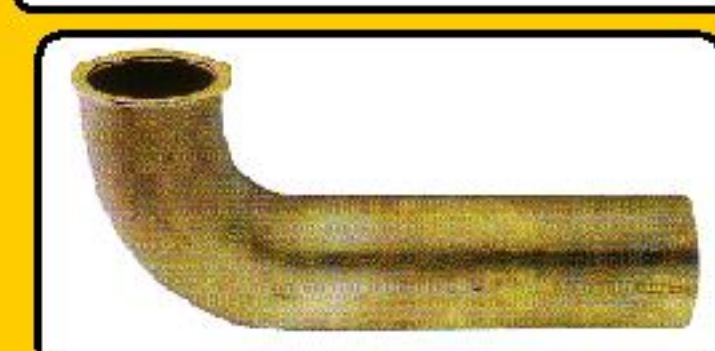

SLIP JOINT ELBOWS

rough brass		chrome pl
41-0701304	1-1/4 x 4	41-0751304
41-0701306	1-1/4 x 6	41-0751306
41-0701308	1-1/4 x 8	41-0751308
41-0701312	1-1/4 x 12	41-0751312
41-0701506	1-1/2 x 6	41-0751506
41-0701508	1-1/2 x 8	41-0751508
41-0701512	1-1/2 x 12	41-0751512



1 PC LOW DOWN FLUSH ELBOWS

Cp furnished with nuts and washers

41-08246 2" x 4" x 6"
41-08268 2" x 6" x 8"

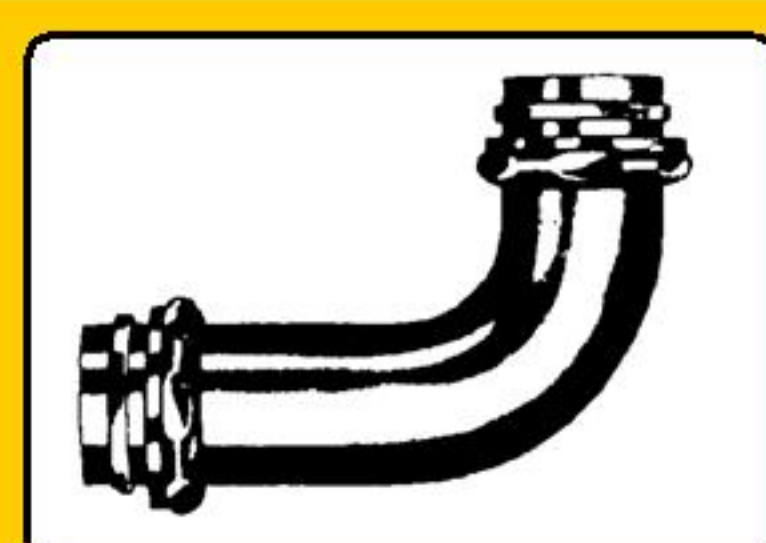

1-1/2" WASTE BEND

rough brass		chrome plated
38-04006	6"	38-04007
38-04008	8"	38-04009
38-04012	12"	38-04013
38-04015	15"	38-04016
38-04018	18"	38-04019
38-04024	24"	38-04025
38-04030	30"	38-04031
38-04036	36"	38-04036
38-04048	48"	38-04049

for PVC see page 77

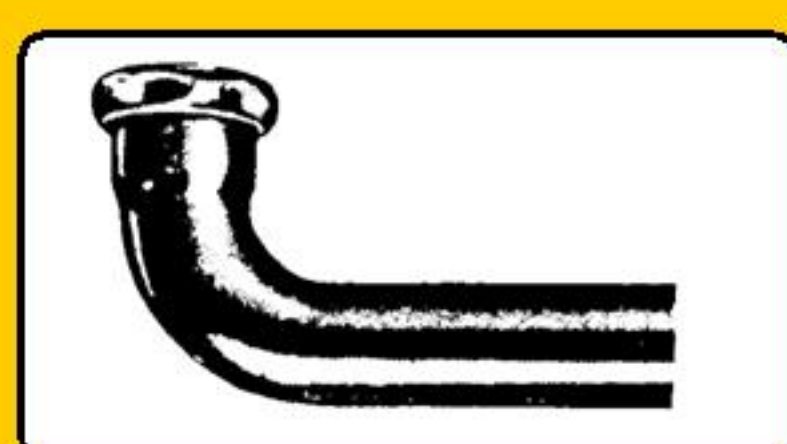

TRAP EXTENSION TUBE

rough brass		chrome plated
42-0101308	1 1/4" x 8	42-0151308
42-0101312	1 1/4" x 12	42-0151312
42-0101508	1 1/2" x 8	42-0151508
42-0101512	1 1/2" x 12	42-0151512

for PVC see page 77

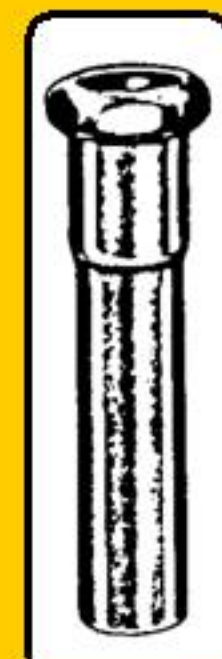

SLOAN TAILPIECE-CP

1 1/4" tubular with 1 1/2" collar

42-03508 1 1/4" x 8"

42-03512 1 1/4" x 12"



EURO TAILPIECE-CP

1 1/4" tubular with 1 1/4" collar

42-15512 1 1/4" x 12"



STANDARD TAILPIECE-CP

42-04008 1 1/2" x 1 1/4" x 8"

42-04012 1 1/2" x 1 1/4" x 12"



LONG BRANCH DISHWASHER TAILPIECE

42-05010 1 1/2" x 10"
42-05012 1 1/2" x 12"
42-05510 1 1/2" x 10" with brass nut
42-05512 1 1/2" x 12" with brass nut
42-05710 1 1/2" x 10 with hose end

for PVC see page 77

OFFSET-ANNEAL BATH SUPPLIES

42-07000 pr. 9/16"od x 20-1/2" CP with nuts and washers
42-07050 Trim kit nuts and washers.
42-07500 pr. 9/16"od x 20-1/2" Stainless Steel Bath Supplies

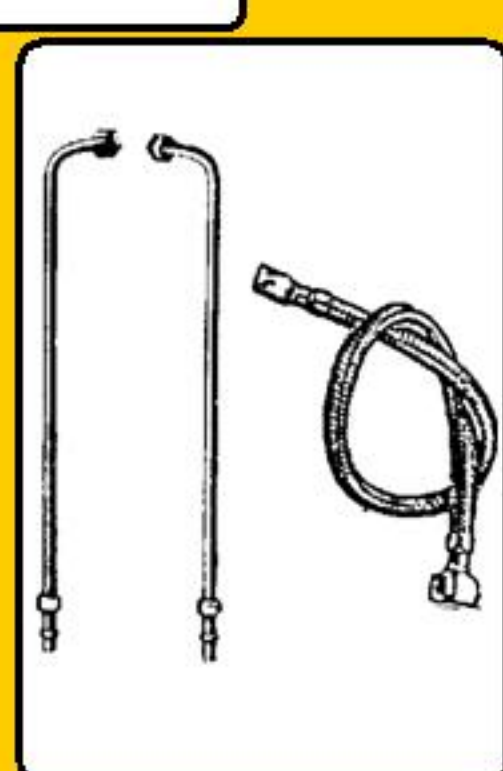

CAST BRASS TUBULAR WASHING MACHINE TAILPIECE

Cast body for durability and tubular ends for versatility.

BP Nuts Brass nuts

42-11008 8" 42-11508

42-11010 10" 42-11510

42-11012 12" 42-11512



TOP TAILPIECE

42-13150 1 1/2" x 1" RB threaded tailpiece

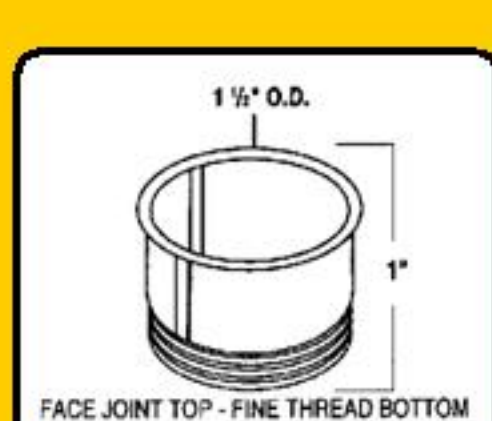

1 1/2" WASTE BEND

rough brass		chrome plated
38-04006	6"	38-04506
38-04008	8"	38-04508
38-04012	12"	38-04512
38-04015	15"	38-04515
38-04018	18"	38-04518
38-04024	24"	38-04524
38-04030	30"	38-04530
38-04036	36"	38-04536
38-04048	48"	38-04548

for PVC see page 77



2 PC LOW DOWN FLUSH ELBOW

CP furnished with nuts and washers

41-09257 2" x 5" x 7"

